

SOVET

ITALIA



Palace

collection booklet

collection booklet

Palace

Design **Lievore Altherr Molina**

“
Palace dining table and its unique design become the outright protagonist of the living area, thanks also to the new shapes. An important element that sets the mood of the whole room.

Il tavolo Palace, grazie al suo design inconfondibile e alle nuove forme, diventa il protagonista assoluto dello spazio giorno: un elemento importante che caratterizza l'intero ambiente.

”

Models & Dimensions

Dining table with lacquered metal base, various finishes, or burnished finish. Tempered or laminated top in different measures, materials and finishes.

Tavolo con base in metallo laccato, varie finiture, o brunito. Top temperato o stratificato in varie misure, materiali e finiture.

rectangular

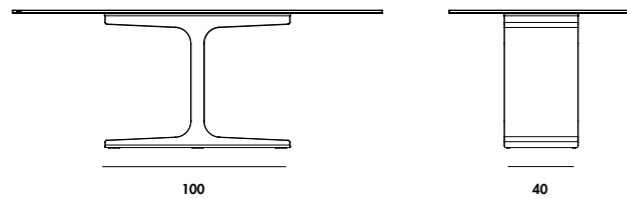

200x100x74h
250x100x74h
240x120x74h

elliptical

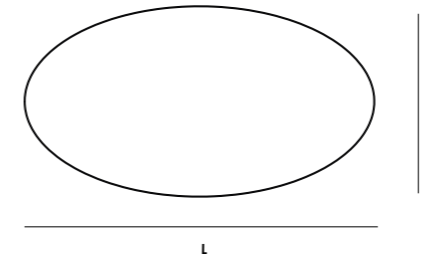
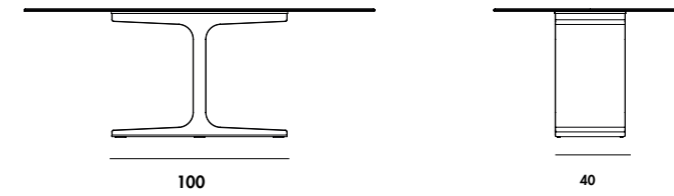

200x110x74h
220x130x74h

botte

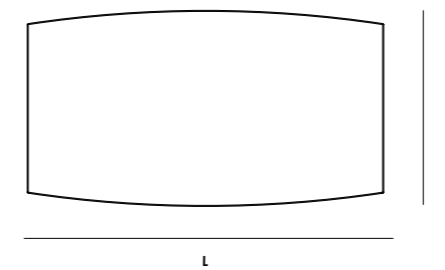
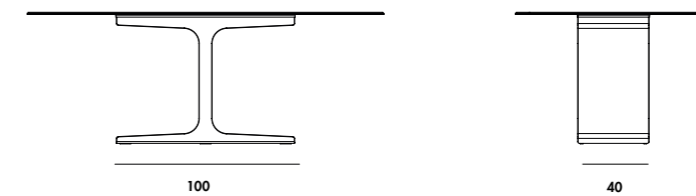

200x110x74h

shaped

220x115x74h
250x120x74h
300x135x74h

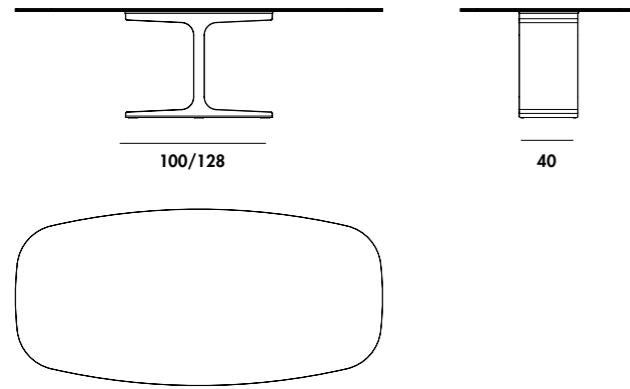

rectangular extensible

Close 170x90x76.5h
200x100x76.5h
220x100x76.5h

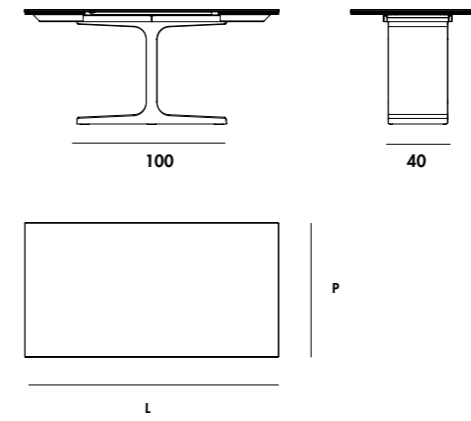

Open 250x90x76.5h
280x100x76.5h
300x100x76.5h

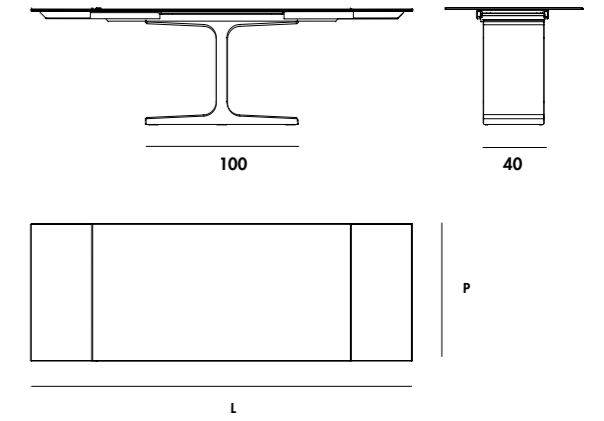

MAXI

460x140x75h

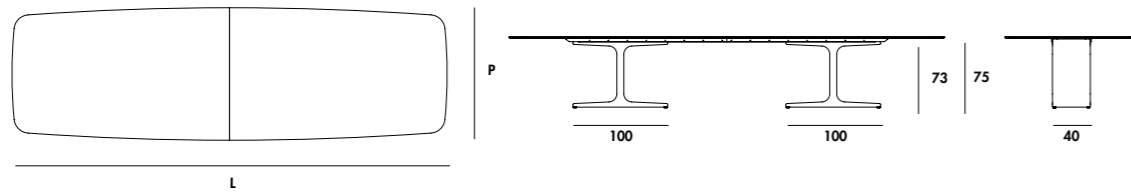

shaped extensible

Close 170x90x76.5h
200x100x76.5h
200x115x76.5h
220x115x76.5h

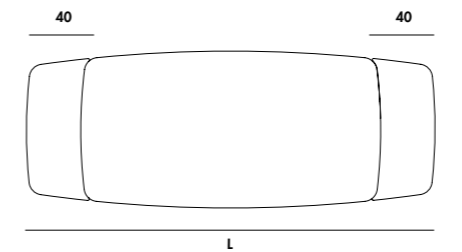

Open 250x90x76.5h
280x100x76.5h
280x115x76.5h
300x115x76.5h

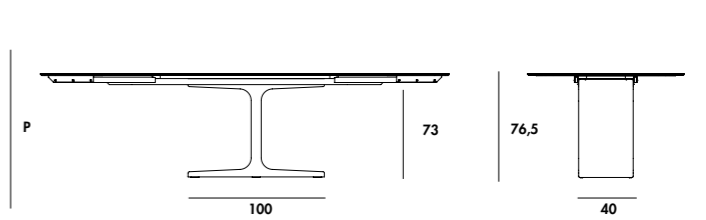

collection
finishes



top

Glass Vetro

CAT. B



TEB1
Extralight glass lacquered milky white
Vetro extrachiaro laccato bianco latte



TEC1
Extralight glass lacquered mocha
Vetro extrachiaro laccato caffè



TEC2
Extralight glass lacquered clay
Vetro extrachiaro laccato creta



TEC3
Extralight glass lacquered cement
Vetro extrachiaro laccato col. cemento



TER4
Extralight glass lacquered rust
Vetro extrachiaro laccato col. ruggine



TEV2
Extralight glass lacquered moss green
Vetro extrachiaro laccato col. muschio



TEN1
Extralight glass lacquered black
Vetro extrachiaro laccato nero

CAT. D



TEM6
Vetro extrachiaro laccato col. tabacco
Extralight glass lacquered tobacco



TES1
Vetro extrachiaro laccato champagne
Extralight glass lacquered champagne

Frosted glass Vetro acidato

CAT. E



AEB1
Extralight glass lacquered mocha
Vetro extrachiaro laccato caffè



AEC2
Frosted clay glass
Vetro acidato creta



AEC3
Frosted cement glass
Vetro acidato col. cemento



AES1
Frosted champagne glass
Vetro acidato champagne

Net glass

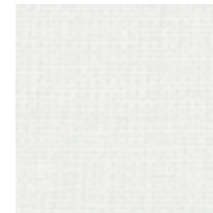

NEB1
White Net glass
Net glass bianco

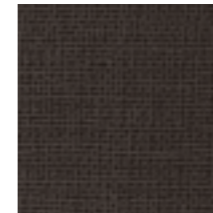

NEC1
Mocha Net glass
Net glass caffè

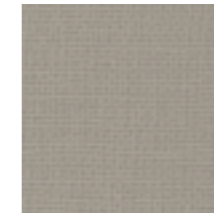

NEC2
Clay Net glass
Net glass creta

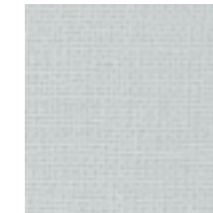

NEC3
Cement Net glass
Net glass col. cemento



NER4
Rust Net glass
Net glass col. ruggine

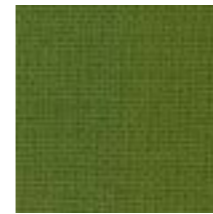

NEV2
Moss green Net glass
Net glass col. muschio

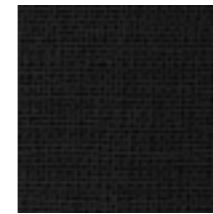

NEN1
Black Net glass
Net glass nero



NEM6
Tobacco Net glass
Net glass col. tabacco



NES1
Champagne Net glass
Net glass champagne

Liquid glass/materia



LFSP
Smoked Liquid glass mirrored
Liquid glass fumè specchiato



LBSP
Bronzed Liquid glass mirrored
Liquid glass bronzo specchiato

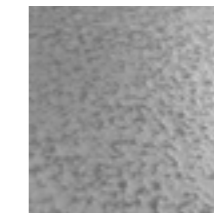

MESP
Extralight mirror materia
Materia extrachiaro specchio



MBSP
Extralight bronzed materia
Materia extrachiaro bronzo



MES1
Extralight champagne materia
Materia extrachiaro champagne

Liquid glass



LFLF
Smoked Liquid glass
Liquid glass fumè



LBLB
Bronzed Liquid glass
Liquid glass bronzo

Wood
Legni



NC
Canaletto walnut
Noce Canaletto



RN
Natural oak wood
Rovere naturale



RG
Grey lacquered oak
Rovere tinto grigio



WG
Wengé-stained oak
Rovere tinto wengè

Ceramic
Ceramica
Categoria CE1

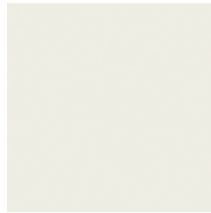

CT
Ceramic titanio
Ceramica titanio



CJ
Ivory black ceramic
Ceramica Ivory Black



CD
Dark ceramic
Ceramica dark

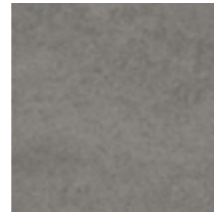

CG
Grey ceramic
Ceramica grey



CZ
Ceppo di Grè ceramic
Ceramica Ceppo di Grè



CC
Pre-polished Calacatta ceramic
Ceramica Calacatta Prelucidata



CX
Pre-polished Stone Grey ceramic
Ceramica Stone Grey Prelucidata



KC
Corten ceramic
Ceramica Corten

Ceramic
Ceramica
Categoria CE2



Arabescato light ceramic
Ceramica Arabescato light



CL
Polished Calacatta ceramic
Ceramica Calacatta lucida



CY
Stone grey ceramic
Ceramica Stone grey



CU
Gaudi Stone ceramic
Ceramica Gaudi Stone

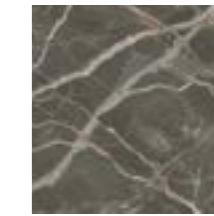

CV
Ombra di Caravaggio ceramic
Ceramica Ombra di Caravaggio

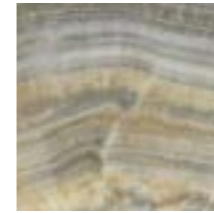

Grey onyx ceramic
Ceramica Onice grigio



CI
Gold Onyx ceramic
Ceramica Onice oro



KO
Black Gold ceramic
Ceramica Black Gold



CQ
Polished Marquinia ceramic
Ceramica Marquinia lucida



CF
Eramosa ceramic
Ceramica Eramosa



Antique ceramic
Ceramica Antique

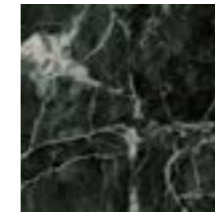

KV
Green Aver ceramic
Ceramica verde Aver

base

Metal

Metallo

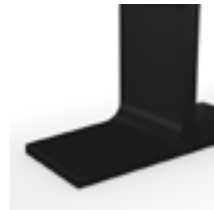

GN

Embossed black
Nero goffrato

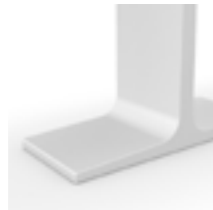

GB

Embossed white
Bianco goffrato



GC

Embossed Mocha
Caffè goffrato



GT

Embossed clay
Creta goffrato



BR

Burnished metal
Metallo brunito

Materiali e manutenzione

ITA

Vetro

Le laccature utilizzate non presentano problemi di durata: basta evitare graffi e urti contro oggetti particolarmente duri e spigolosi. Il vetro è colorato solo sulla faccia posteriore sia nei vetri laccati coprenti mono e bicolore che nei vetri acidati laccati. La tonalità dei campioni proposti è indicativa e non va pertanto intesa in senso restrittivo; può infatti differire leggermente in conformità ai margini di tolleranza riconosciuti per i materiali impiegati. I materiali impiegati possono essere puliti tranquillamente solo con acqua oppure con un detergente neutro. Evitare l'uso di abrasivi, acidi o reagenti chimici. Il vetro è interpretato attraverso la sua trasparenza, pertanto la conformità al campione può differire a seconda della superficie e degli spessori impiegati. Un esempio lampante è dato dal vetro extrachiaro che nei campioncini si presenta completamente neutro ma che nei piani di dimensioni maggiori e con spessori più consistenti assume sfumature azzurro/verdi. Per tale ragione vi preghiamo anche di segnalare con particolare attenzione articoli che debbano essere affiancati o facenti parte di una stessa commissione.

La finitura bicolore consiste nella doppia laccatura nella parte interna della lastra di vetro. La prima laccatura, visibile attraverso la trasparenza del vetro, è disponibile nelle categorie B-D. La seconda laccatura, visibile internamente, equivale al colore pastello opaco utilizzato per ottenere le finiture di cat. B. Vi facciamo presente che in questo caso l'effetto finale differisce da quello creato dalla medesima laccatura attraverso il vetro, in particolare nei colori tenui.

Specchi

Gli specchi oro e rosa potrebbero presentare delle piccole imperfezioni dovute alle caratteristiche tecniche del materiale. Non possono essere utilizzati in luoghi umidi. Pulire solo con panni asciutti.

Ceramica

I campioni riportati sono una parte delle lastre che vengono lavorate. La lastra completa si può vedere nella corrispondente cartella. Pulire utilizzando acqua e una piccola quantità di detergente neutro. Evitare l'utilizzo di detersivi contenenti cere e prodotti ceranti per evitare la formazione di strati untuosi.

Legno

I colori dei legni sono campioni indicativi. Pulire utilizzando un panno morbido inumidito.

Metalli

I colori dei metalli sono campioni indicativi. Pulire utilizzando un panno morbido inumidito.

Tessuti/Pelli/Ecopelli/Velluti

I colori dei tessuti sono campioni indicativi. Per la cura e la manutenzione fare riferimento alle indicazioni riportate nelle rispettive cartelle e alle schede tecniche fornite dai produttori.

Se permangono dubbi contattare l'azienda.

Colours and maintenance

ENG

Glass

The lacquering used for our furniture is extremely durable as long as you avoid scratching it or bumping particularly hard/sharp objects against it. The glass is lacquered only on the back side both for mono or two-tones lacquered and frosted lacquered glasses. The shade of the samples is only indicative and has not to be taken as restrictive. It can in fact slightly differ in conformity to the tolerances recognized for the materials used. All the materials we use can be easily cleaned with water only or with a mild detergent. Do not use abrasive materials, acids or harsh chemicals. The glass is interpreted through its transparency, therefore the conformity to the sample might differ according to the surface and the thickness used. For example, the extralight glass is completely neutral when seen in the small samples, but it takes a light blue/greenish shade when used on bigger or thicker tops. For this reason, we beg you to indicate carefully those articles which have to be placed side by side or which are part of the same commission.

The two-tones finish consists of a double lacquering on the internal part of the glass sheet. The first lacquering, which is visible through the transparency of the glass, is available in the finishes of cat. B-D. The second lacquering, which is visible internally, is the same of the mat pastel used to get the finishes of cat. B. Please notice that the final effect is different from the one created by the same lacquering through the glass, in particular when it comes to soft colours.

Mirrors

Gold and rose mirrors could have small imperfections due to the particular technical characteristics of the material. We recommend not to use them in damp areas. Clean only with a dry cloth.

Ceramic

The shown samples are part of the bigger slabs Sovet works with. The complete slab is visible in the corresponding folder. Clean using water and a small amount of neutral detergent. Avoid using detergents with wax and waxing products to avoid the formation of greasy layers.

Wood

Wood colours are indicative samples. Clean using a damp soft cloth.

Metals

Metals colours are indicative samples. Clean using a damp soft cloth.

Fabrics/Leathers/Fake leathers/velvets

Fabrics colours are indicative samples. For care and maintenance please refer to the instructions present in the corresponding folders and to the technical sheets provided by the manufacturers.

In case of further doubt please get in touch with the factory.

Bordi/Edges

VETRO / ACIDATO GLASS / FROSTED	VETRO / ACIDATO GLASS / FROSTED	VETRO / ACIDATO GLASS / FROSTED	NET GLASS	CERAMICA strat. VETRO CERAMIC laminat. GLASS	CERAMICA strat. VETRO CERAMIC laminat. GLASS	LEGNO WOOD
12 Filo lucido	15 Filo lucido	12 Filo lucido 45°	12 Filo lucido	13 Filo lucido 45° (6+6)	15 Filo lucido 45° (6+8)	24 Filo 45°

220x115x74h						
250x120x74h						
300x135x74h						
200x100x74h						
250x100x74h						
240x120x74h						
200x110x74h						
200x110x74h						
220x130x74h						
170x90x74h Extensible						
200x100x74h Extensible						
200x110x74h Extensible						





Palace base BR top CA.
Pura chairs in Kvadrat hallingdal 153.



In the previous pages Palace shaped base GC top CU
and Autumn chairs in NF and P54 seat.



Palace shaped base BR top CO.
Autumn chairs structure DF seat P53.



Palace shaped base BR top CO.



Palace shaped base GN top CQ.
Cadeira cone shaped base GN velvet Z06.
Madia Slim base GN structure WG.



Palace shaped base GN top CQ.
 Cadira cone shaped base GN velvet Z06.



Palace shaped base GN top CQ.
 Cadira s wire base GN Trevira F05.





designer

Lievore Altherr Molina

Lievore Altherr Molina, was founded by Alberto Lievore, Jeannette Altherr and Manel Molina in 1991. The Studio focuses on product design, consultancy and art direction work for a number of companies, offering personalized solutions to industry. Known by its furniture design, it also develops interior design projects, packaging and product design. In many opportunities, the Studio gives seminars and courses cooperating with several Spanish universities in forming new professionals. It currently works for firms in Spain, Italy and the United States, outstanding its projects for companies such as Andreu World, Arketipo, Arper, Arruti, Bellato, Bernhardt, Casamilano, Do+Ce, Dona, Emmebi, Foscarini, Halifax, Metalarte, Orizzonti, Perobell, Poltrona Frau, Roda, Santa & Cole, Segis, Sellex, Sovet, Sunroller, Tacchini, Tisettanta, Verzelloni, Vibia, etc. Award-winner with Spanish National Design Award (1999) it has received numerous awards and special mentions, both in Spain and abroad, for its work, including several ADI-FAD Deltas Gold and Silver. It has held both individual and joint exhibitions in Barcelona, Cologne, Chicago, Stockholm, Helsinki, Lisbon, London, Louisiana, Madrid, Malmö, Milan, New York, Paris and Tokyo. Its designs are featured regularly in Spanish and international trade magazines.

Lo Studio Lievore Altherr Molina è composto da Alberto Lievore, Jeannette Altherr e Manel Molina, che hanno formato una società nel 1991. Lo Studio si dedica all'industrial design, alla consulenza e alla direzione d'arte di diverse ditte, offrendo soluzioni personalizzate alle aziende. Conosciuto per i suoi progetti d'arredamento, sviluppa inoltre progetti di design d'interni, packaging e industrial design. Oltre a tali attività, si ricorda la docenza esercitata in seminari, workshop e conferenze, presso diverse Università spagnole aiutando la formazione di nuovi professionisti. Attualmente svolge attività in Spagna, Italia e Stati Uniti, collaborando con aziende come Andreu World, Arketipo, Arper, Arruti, Bellato, Bernhardt, Casamilano, Do+Ce, Dona, Emmebi, Foscarini, Halifax, Metalarte, Orizzonti, Perobell, Poltrona Frau, Roda, Santa & Cole, Segis, Sellex, Sovet, Sunroller, Tacchini, Tisettanta, Verzelloni, Vibia, etc. Lo studio ha ricevuto numerosi premi e riconoscimenti nazionali e internazionali per i lavori svolti, tra cui il Premio Nacional de Diseño (1999) e diversi Delta de Oro e Delta de Plata dell'ADI-FAD. Ha realizzato mostre personali ed esposizioni a Barcellona, Colonia, Chicago, Stoccolma, Helsinki, Lisbona, Londra, in Louisiana, a Madrid, Malmö, Milano, New York, Parigi e Tokyo. I lavori vengono pubblicati regolarmente su tutte le riviste specializzate nazionali ed estere.



sustainability is made up of facts.

Sovet has always maintained a high attention to eco-compatibility since its birth in 1987, through the selection of raw materials and the study of production processes that have the lowest impact on the environment with the aim of creating long-lasting products.

Sovet ha sempre mantenuto alta l'attenzione all'ecocompatibilità sin dalla sua nascita nel 1987, attraverso la selezione delle materie prime e lo studio di processi produttivi che abbiano il minimo impatto sull'ambiente con lo scopo di creare prodotti durevoli nel tempo.

photovoltaic systems

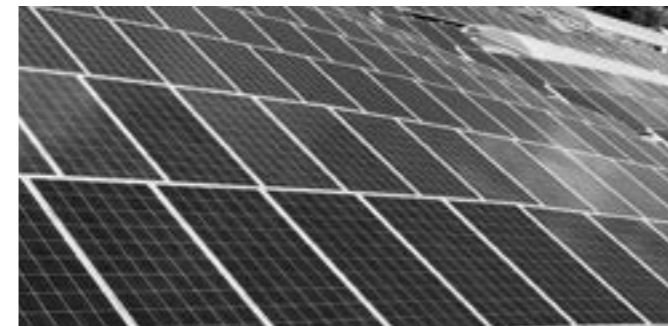

For its production processes, Sovet uses energy coming directly from renewable sources. Thanks to its photovoltaic systems, it is able to meet its own energy demand.

Per la sua produzione Sovet utilizza infatti energia derivante direttamente da fonti rinnovabili. Attraverso impianti fotovoltaici riesce a soddisfare il proprio fabbisogno energetico.



502695,549 kg emmissions saved per year



2989 trees saved per year



165 barrels of oil saved per year

packaging



Sovet uses cardboard packaging with limited presence of oil-derivates.

Sovet usa imballi di cartone costruiti ad hoc con limitata presenza di derivati del petroli.



reducing plastic is an habits



To reduce the consumption of plastic and disposable bottles within its offices and production, Sovet created metal water bottles.

Per ridurre il consumo di plastica e bottiglie monouso all'interno dei suoi uffici e della produzione, Sovet ha creato delle borracce in metallo.

made in italy

The creative use of industrial processes, the use of raw materials of highest quality and the scrupulous work of master craftsmen, allow Sovet to create high quality and 100% Made in Italy collections. Thanks to state-of-the-art industrial automation systems, Sovet is also able to meet also large supply needs for contract spaces, always granting the highest quality standards. The company takes a continuous search path for materials, to create an offer of accessories that complement one another, furnishing different kinds of environments with the maximum freedom when it comes to customization.

L'impiego creativo dei processi industriali, l'utilizzo di materie prime di assoluta qualità e le scrupolose lavorazioni eseguite da maestranze artigiane, permettono a Sovet di ottenere collezioni di alta qualità e 100% Made in Italy. Grazie a sistemi di automazione industriale all'avanguardia Sovet è in grado di soddisfare anche esigenze per grandi forniture destinate a spazi contract, sempre garantendo i più elevati standard qualitativi. Sovet intraprende un percorso di ricerca dei materiali per creare un'offerta di complementi che si integrino tra di loro, arredando varie tipologie di ambienti con la massima possibilità di personalizzazione.





[sovet.com](https://www.sovet.com)