

SOVET

ITALIA



Campos

collection booklet

collection booklet

Campos

Design Altherr Désile Park

“
The Campos collection is now enriched with a range of coffee tables outlined by the graphic and minimalist design of the structure. The combination between ceramic and mirror for the top creates a refined balance for the contemporary furnishing.

La collezione Campos si amplia con una gamma di tavolini delineata dal segno grafico e minimalista della struttura. L'accostamento di ceramica e specchio per i piani crea un raffinato equilibrio per l'arredare contemporaneo.

”

Models & Dimensions

Coffee table with lacquered metal structure, various finishes. Top in mirror or ceramic, various finishes.

Tavolino con struttura in metallo laccato, varie finiture. Piano in specchio o ceramica, varie finiture.

campos coffee tables

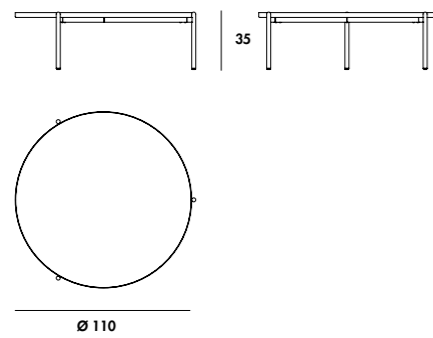
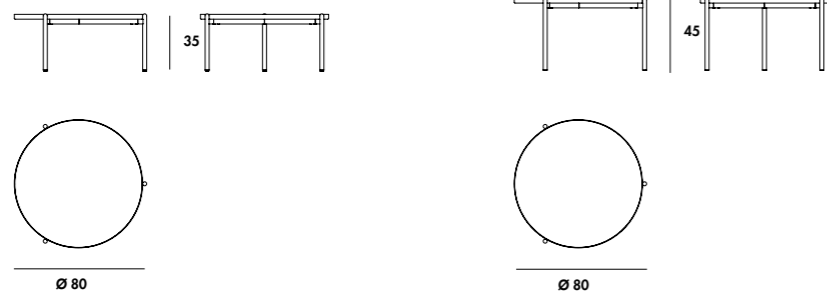
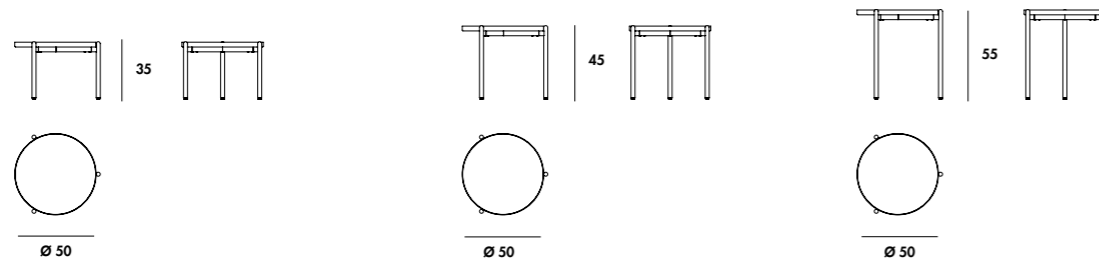

- Ø 50x35h
- Ø 50x45h
- Ø 50x55h
- Ø 80x35h
- Ø 80x45h
- Ø 110x35h

Coffee table with lacquered metal structure, various finishes. Top available in different combinations. Available other finishes combinations upon request.

Tavolino con struttura in metallo laccato, varie finiture. Piano disponibile in varie combinazioni. Su richiesta è possibile avere altri accostamenti di finiture.

campos coffee tables two tones

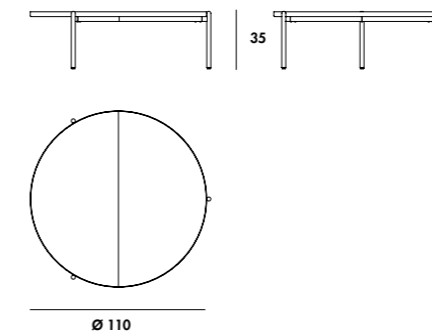
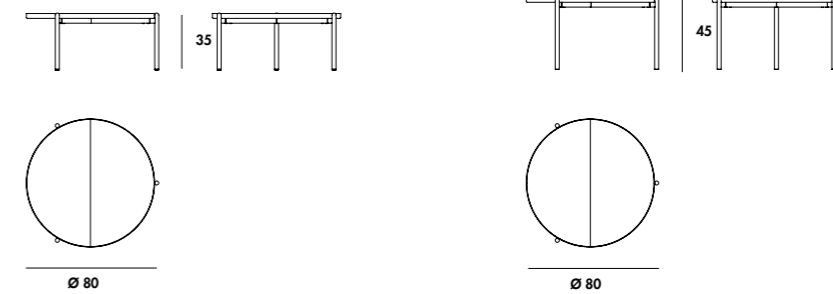
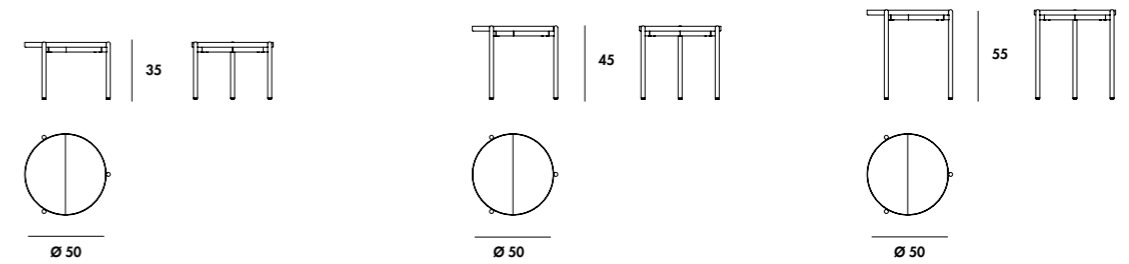

- Ø 50x35h
- Ø 50x45h
- Ø 50x55h
- Ø 80x35h
- Ø 80x45h
- Ø 110x35h

Legs fixing system

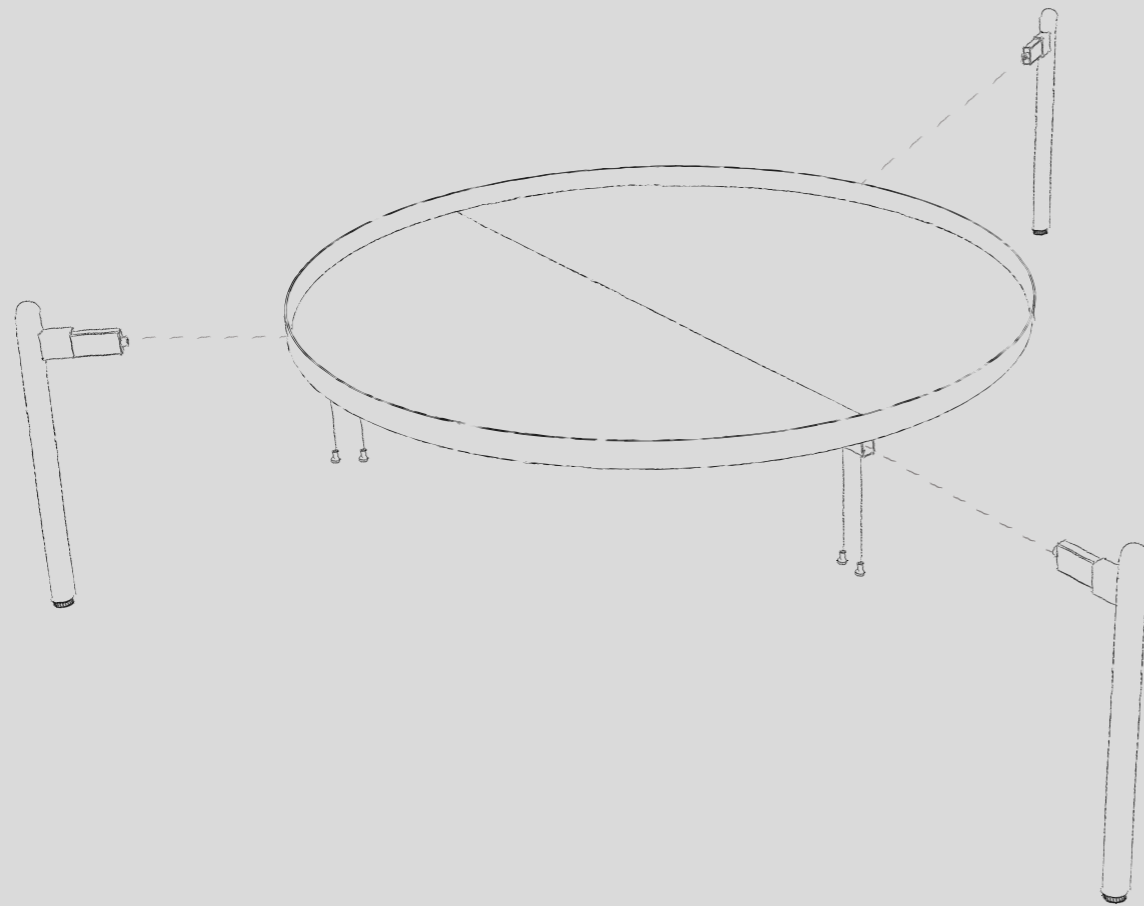

Legs

Top



Re-use

/ One of the principles of sustainability is the reuse of materials from manufacturing. In Campos two-tone the crescent shape allows for the utilization of material that otherwise would not be used.

/ Uno dei principi della sostenibilità è il riutilizzo di materiali provenienti dalle lavorazioni. In Campos two tone la forma a mezzaluna permette di utilizzare delle parti di ceramica e specchio che altrimenti non troverebbero impiego.

Example cut of ceramic slab

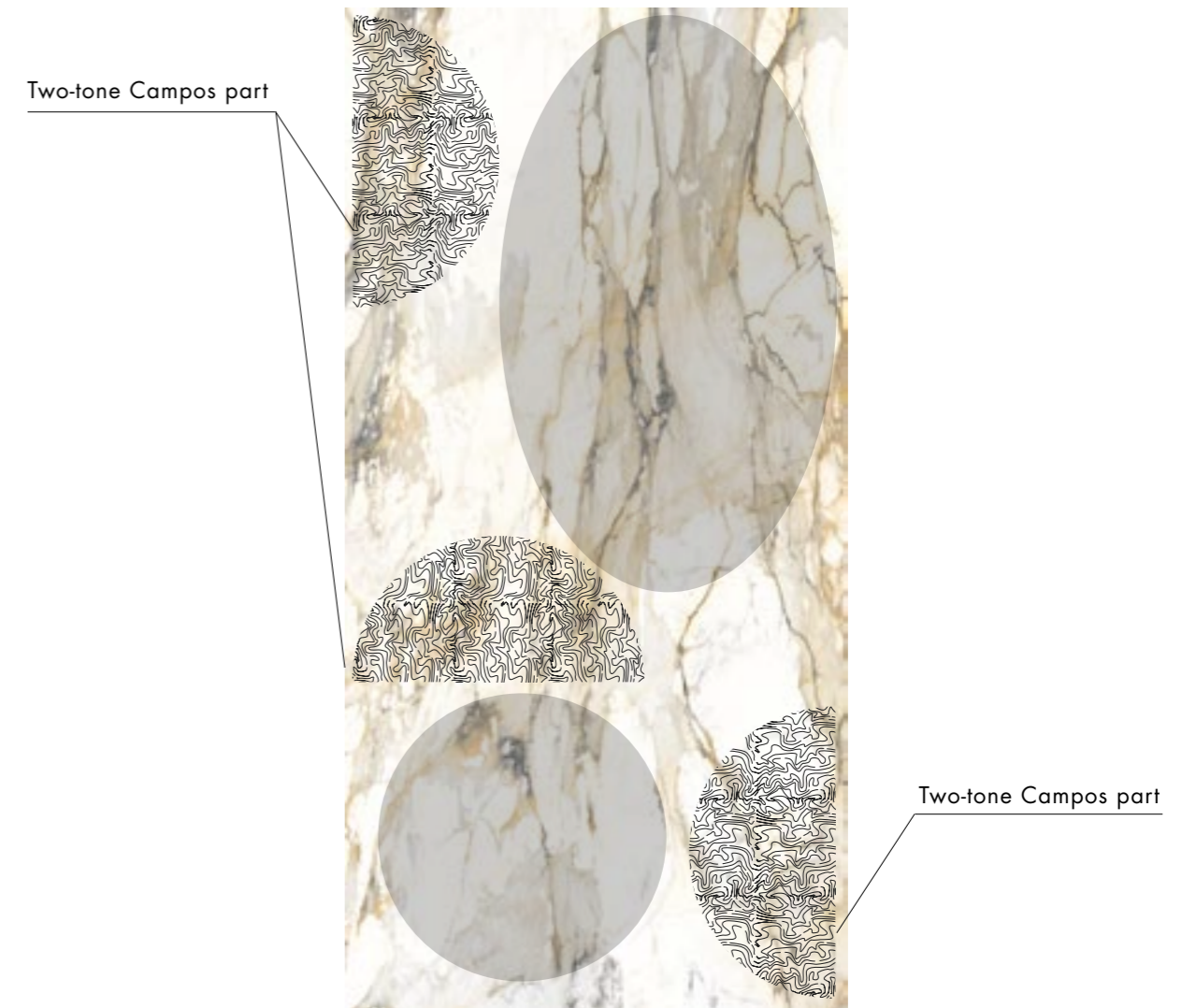

collection
finishes



Mirror
Specchio



SESP
Extralight mirror
Specchio extrachiaro



SFSP
Smoked mirror
Specchio fumé



SBSP
Bronzed mirror
Specchio bronzo



SRSP *
Rose mirror
Specchio rosa



SOSP *
Gold mirror
Specchio oro

Ceramic
Ceramica
Categoria CE2



CA
Arabescato light
ceramic
Ceramica Arabescato
light



CL
Polished Calacatta
ceramic
Ceramica Calacatta
lucida



CY
Stone grey ceramic
Ceramica Stone grey

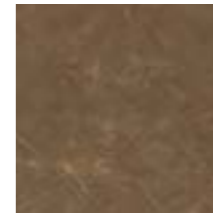

CU
Gaudi Stone ceramic
Ceramica Gaudi Stone

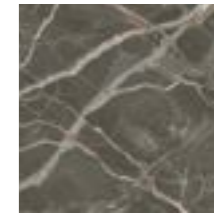

CV
Ombra di Caravaggio
ceramic
Ceramica Ombra di
Caravaggio

Ceramic
Ceramica
Categoria CE1

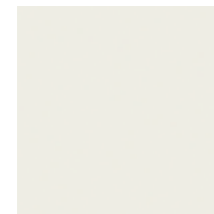

CT
Ceramic titanio
Ceramica titanio



CJ
Ivory black ceramic
Ceramica Ivory Black

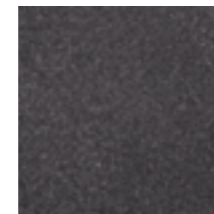

CD
Dark ceramic
Ceramica dark



CG
Grey ceramic
Ceramica grey

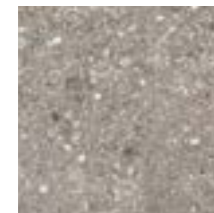

CZ
Ceppo di Grè ceramic
Ceramica Ceppo di Grè



CC
Pre-polished Calacatta
ceramic
Ceramica Calacatta
Prelucidata



CX
Pre-polished Stone
Grey ceramic
Ceramica Stone Grey
Prelucidata



KC
Corten ceramic
Ceramica Corten

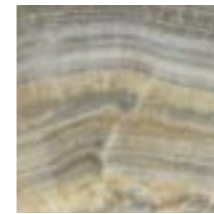

CH
Grey onyx ceramic
Ceramica Onice grigio



CI
Gold Onyx ceramic
Ceramica Onice oro

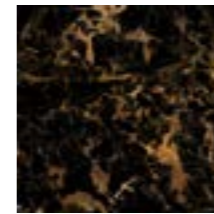

KO
Black Gold ceramic
Ceramica Black Gold



CQ
Polished Marquinia
ceramic
Ceramica Marquinia
lucida



CF
Eramosa ceramic
Ceramica Eramosa



CW
Antique ceramic
Ceramica Antique

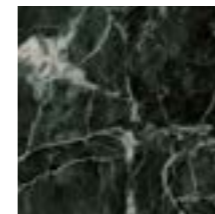

KV
Green Aver ceramic
Ceramica verde Aver

*
Gli specchi oro e rosa potrebbero presentare delle piccole imperfezioni dovute alle caratteristiche tecniche del materiale. Non possono essere utilizzati in luoghi umidi. Pulire solo con panni asciutti.
Gold and rose mirrors could have small imperfections due to the particular technical characteristics of the material. We recommend not to use them in damp areas. Clean only with a dry cloth.

top two tone

Mirror Specchio

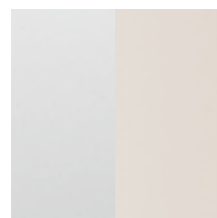

SFSP
Smoked mirror
Specchio fumé

SBSP
Bronzed mirror
Specchio bronzo



SFSP
Smoked mirror
Specchio fumé

*** SOSP**
Gold mirror
Specchio oro



SBSP
Bronzed mirror
Specchio bronzo

*** SOSP**
Gold mirror
Specchio oro

Mirror / Ceramic Specchio / Ceramica



SFSP
Smoked mirror
Specchio fumé

CA
Arabescato light ceramic
Ceramica Arabescato light

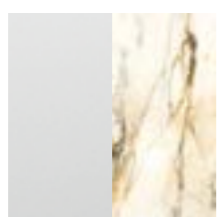

SFSP
Smoked mirror
Specchio fumé

CW
Antique ceramic
Ceramica Antique



SBSP
Bronzed mirror
Specchio bronzo

CA
Arabescato light ceramic
Ceramica Arabescato light

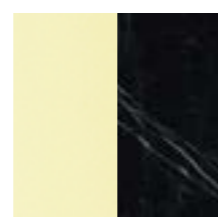

SOSP *
Gold mirror
Specchio oro

CQ
Polished Marquinia ceramic
Ceramica Marquinia lucida

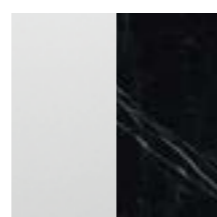

SFSP
Smoked mirror
Specchio fumé

CQ
Polished Marquinia ceramic
Ceramica Marquinia lucida

Metals Metalli



GN
Embossed black
Nero gofrato

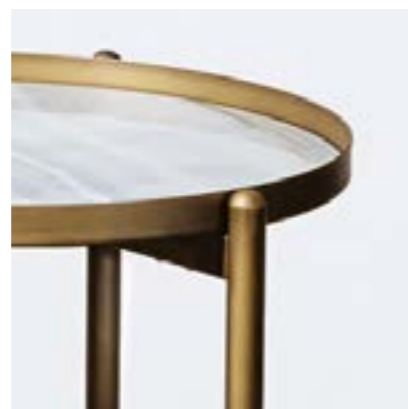

BR
Burnished metal
Metallo brunito

* Gli specchi oro e rosa potrebbero presentare delle piccole imperfezioni dovute alle caratteristiche tecniche del materiale. Non possono essere utilizzati in luoghi umidi. Pulire solo con panni asciutti.
Gold and rose mirrors could have small imperfections due to the particular technical characteristics of the material. We recommend not to use them in damp areas. Clean only with a dry cloth.

Materiali e manutenzione

ITA

Vetro

Le laccature utilizzate non presentano problemi di durata: basta evitare graffi e urti contro oggetti particolarmente duri e spigolosi. Il vetro è colorato solo sulla faccia posteriore sia nei vetri laccati coprenti mono e bicolore che nei vetri acidati laccati. La tonalità dei campioni proposti è indicativa e non va pertanto intesa in senso restrittivo; può infatti differire leggermente in conformità ai margini di tolleranza riconosciuti per i materiali impiegati. I materiali impiegati possono essere puliti tranquillamente solo con acqua oppure con un detergente neutro. Evitare l'uso di abrasivi, acidi o reagenti chimici. Il vetro è interpretato attraverso la sua trasparenza, pertanto la conformità al campione può differire a seconda della superficie e degli spessori impiegati. Un esempio lampante è dato dal vetro extrachiaro che nei campioncini si presenta completamente neutro ma che nei piani di dimensioni maggiori e con spessori più consistenti assume sfumature azzurro/verdi. Per tale ragione vi preghiamo anche di segnalare con particolare attenzione articoli che debbano essere affiancati o facenti parte di una stessa commissione.

La finitura bicolore consiste nella doppia laccatura nella parte interna della lastra di vetro. La prima laccatura, visibile attraverso la trasparenza del vetro, è disponibile nelle categorie B-D. La seconda laccatura, visibile internamente, equivale al colore pastello opaco utilizzato per ottenere le finiture di cat. B. Vi facciamo presente che in questo caso l'effetto finale differisce da quello creato dalla medesima laccatura attraverso il vetro, in particolare nei colori tenui.

Specchi

Gli specchi oro e rosa potrebbero presentare delle piccole imperfezioni dovute alle caratteristiche tecniche del materiale. Non possono essere utilizzati in luoghi umidi. Pulire solo con panni asciutti.

Ceramica

I campioni riportati sono una parte delle lastre che vengono lavorate. La lastra completa si può vedere nella corrispondente cartella. Pulire utilizzando acqua e una piccola quantità di detergente neutro. Evitare l'utilizzo di detersivi contenenti cere e prodotti ceranti per evitare la formazione di strati untuosi.

Legno

I colori dei legni sono campioni indicativi. Pulire utilizzando un panno morbido inumidito.

Metalli

I colori dei metalli sono campioni indicativi. Pulire utilizzando un panno morbido inumidito.

Tessuti/Pelli/Ecopelli/Velluti

I colori dei tessuti sono campioni indicativi. Per la cura e la manutenzione fare riferimento alle indicazioni riportate nelle rispettive cartelle e alle schede tecniche fornite dai produttori.

Se permangono dubbi contattare l'azienda.

Colours and maintenance

ENG

Glass

The lacquering used for our furniture is extremely durable as long as you avoid scratching it or bumping particularly hard/sharp objects against it. The glass is lacquered only on the back side both for mono or two-tones lacquered and frosted lacquered glasses. The shade of the samples is only indicative and has not to be taken as restrictive. It can in fact slightly differ in conformity to the tolerances recognized for the materials used. All the materials we use can be easily cleaned with water only or with a mild detergent. Do not use abrasive materials, acids or harsh chemicals. The glass is interpreted through its transparency, therefore the conformity to the sample might differ according to the surface and the thickness used. For example, the extralight glass is completely neutral when seen in the small samples, but it takes a light blue/greenish shade when used on bigger or thicker tops. For this reason, we beg you to indicate carefully those articles which have to be placed side by side or which are part of the same commission.

The two-tones finish consists of a double lacquering on the internal part of the glass sheet. The first lacquering, which is visible through the transparency of the glass, is available in the finishes of cat. B-D. The second lacquering, which is visible internally, is the same of the mat pastel used to get the finishes of cat. B. Please notice that the final effect is different from the one created by the same lacquering through the glass, in particular when it comes to soft colours.

Mirrors

Gold and rose mirrors could have small imperfections due to the particular technical characteristics of the material. We recommend not to use them in damp areas. Clean only with a dry cloth.

Ceramic

The shown samples are part of the bigger slabs Sovet works with. The complete slab is visible in the corresponding folder. Clean using water and a small amount of neutral detergent. Avoid using detergents with wax and waxing products to avoid the formation of greasy layers.

Wood

Wood colours are indicative samples. Clean using a damp soft cloth.

Metals

Metals colours are indicative samples. Clean using a damp soft cloth.

Fabrics/Leathers/Fake leathers/velvets

Fabrics colours are indicative samples. For care and maintenance please refer to the instructions present in the corresponding folders and to the technical sheets provided by the manufacturers.

In case of further doubt please get in touch with the factory.



Campos coffee table P4793 Ø 80x35h structure GN top two tone SFSP/CA.

Campos coffee table P4795 Ø 110x35h structure BR top CV.

Campos coffee table P4792 Ø 50x55h structure BR top CH grey onyx.

Campos coffee table P4791/1 Ø 50x45h structure GN top two tone SFSP/SBSP.



Campos coffee table P4793 Ø 80x35h structure GN top CL.



Campos coffee table P4793 Ø 80x35h structure BR top CQ/CA.
Campos coffee table P4792 Ø 50x55h structure BR top SBSP/SOSP.



Campos coffee table P4795 Ø 110x35h structure BR top CV.

Campos coffee table P4791/1 Ø 50x45h structure GN top two tone SFSP/SBSP.

Campos coffee table P4792 Ø 50x55h structure BR top CH grey onyx.



Campos coffee table P4793 Ø 80x35h structure GN top CZ.



Campos coffee table P4794 Ø 80x45h structure BR top CQ.
Campos coffee table P4795/1 Ø 80x35h structure GN top SFSP/CQ.



designer

Altherr Désile Park

Jeannette Altherr, Delphine Désile and Dennis Park are a collective of professionals collaborating across different constellations. The Barcelona-based studio specializes in product design & development, strategic consulting, creative direction, art direction, and ephemeral architecture for internationally recognized design companies. The studio develops projects using an established strategy: a creative concept integrating product design and its communication. This holistic approach, humanist character, and the search for the essential in their projects – combined with a sensibility that transmits harmony and balance – characterize the designs of Altherr Désile Park.

Jeannette Altherr, Delphine Désile e Dennis Park sono un collettivo di professionisti che collaborano attraverso differenti costellazioni. Lo studio, situato a Barcellona, è specializzato nel product design & sviluppo, nella consulenza strategica, nella direzione creativa e artistica e nell'architettura per rinomate aziende di design internazionali. Lo studio sviluppa progetti usando una strategia stabilita: un concetto creativo di integrazione del prodotto e della sua comunicazione. Questo approccio olistico, dal carattere umanista e la ricerca dell'essenziale nei loro progetti – combinata con una sensibilità che trasmette armonia ed equilibrio caratterizzano il design di Altherr Désile Park.



sustainability is made up of facts.

Sovet has always maintained a high attention to eco-compatibility since its birth in 1987, through the selection of raw materials and the study of production processes that have the lowest impact on the environment with the aim of creating long-lasting products.

Sovet ha sempre mantenuto alta l'attenzione all'ecocompatibilità sin dalla sua nascita nel 1987, attraverso la selezione delle materie prime e lo studio di processi produttivi che abbiano il minimo impatto sull'ambiente con lo scopo di creare prodotti durevoli nel tempo.

photovoltaic systems



For its production processes, Sovet uses energy coming directly from renewable sources. Thanks to its photovoltaic systems, it is able to meet its own energy demand.

Per la sua produzione Sovet utilizza infatti energia derivante direttamente da fonti rinnovabili. Attraverso impianti fotovoltaici riesce a soddisfare il proprio fabbisogno energetico.



502695,549 kg emmissions saved per year



2989 trees saved per year



165 barrels of oil saved per year

packaging



Sovet uses cardboard packaging with limited presence of oil-derivates.

Sovet usa imballi di cartone costruiti ad hoc con limitata presenza di derivati del petroli.



reducing plastic is an habits



To reduce the consumption of plastic and disposable bottles within its offices and production, Sovet created metal water bottles.

Per ridurre il consumo di plastica e bottiglie monouso all'interno dei suoi uffici e della produzione, Sovet ha creato delle borracce in metallo.

made in italy

The creative use of industrial processes, the use of raw materials of highest quality and the scrupulous work of master craftsmen, allow Sovet to create high quality and 100% Made in Italy collections. Thanks to state-of-the-art industrial automation systems, Sovet is also able to meet also large supply needs for contract spaces, always granting the highest quality standards. The company takes a continuous search path for materials, to create an offer of accessories that complement one another, furnishing different kinds of environments with the maximum freedom when it comes to customization.

L'impiego creativo dei processi industriali, l'utilizzo di materie prime di assoluta qualità e le scrupolose lavorazioni eseguite da maestranze artigiane, permettono a Sovet di ottenere collezioni di alta qualità e 100% Made in Italy. Grazie a sistemi di automazione industriale all'avanguardia Sovet è in grado di soddisfare anche esigenze per grandi forniture destinate a spazi contract, sempre garantendo i più elevati standard qualitativi. Sovet intraprende un percorso di ricerca dei materiali per creare un'offerta di complementi che si integrino tra di loro, arredando varie tipologie di ambienti con la massima possibilità di personalizzazione.





[sovet.com](https://www.sovet.com)